

Endothelin 1 Transcription Is Controlled by Nuclear Factor- κ B in AGE-Stimulated Cultured Endothelial Cells

P. Quehenberger, A. Bierhaus, P. Fasching, C. Muellner, M. Klevesath, M. Hong, G. Stier, M. Sattler, E. Schleicher, W. Speiser, and Peter P. Nawroth

Incubation of bovine aortic endothelial cells (BAECs) with erythrocytes from patients with type 2 diabetes induced an increase in endothelin 1 (ET-1) production. The effect of erythrocytes on ET-1 synthesis was dependent on glycemic control. ET-1 levels after incubation with erythrocytes derived from patients with HbA_{1c} levels <6% were just half the levels observed after incubation with erythrocytes from patients with HbA_{1c} levels >8%. N^ε-(carboxymethyl)lysine (CML)-containing protein isolated from patients' erythrocytes induced ET-1, and CML-containing protein-dependent ET-1 induction was blocked by the recombinant decoy peptide soluble receptor for advanced glycation end products (AGEs), which comprises the NH₂-terminal Ig domain of the receptor for AGEs. In vitro-generated AGEs induced ET-1 mRNA transcription (nuclear run-on assay and Northern blot) in a time- and dose-dependent manner. Transient transfection of BAECs with a chimeric construct containing the 5' promoter region of the ET-1 gene linked to a reporter gene confirmed that AGE induced ET-1 promoter activity. Electrophoretic mobility shift assay confirmed AGE-inducible binding of members of the nuclear factor- κ B (NF- κ B) family to a potential binding site at -2,090 bp. Binding was functionally significant because overexpression of the cytoplasmic inhibitor of NF- κ B or deletion of the NF- κ B binding site reduced ET-1 induction, whereas overexpression of NF- κ B p65 induced ET-1 even in the absence of AGEs. Thus, ET-1 transcription is con-

trolled by the AGE-inducible redox-sensitive transcription factor NF- κ B. *Diabetes* 49:1561-1570, 2000

Endothelin 1 (ET-1), a 21-amino acid peptide, is known to be one of the most potent vasoconstrictors and to be a mitogen (1,2). ET-1 mRNA is constitutively expressed in cultured endothelial cells (ECs). The release of ET-1 from ECs can be stimulated by several factors such as interleukin-1, tumor necrosis factor- α , thrombin, angiotensin II, and oxygen radicals (3-7). ET-1 is first transcribed as the precursor molecules prepro-ET-1 and pro-ET-1 and is later processed to the biologically active ET-1 by the endothelin-converting enzyme (8). A significant increase in circulating ET-1 in patients with advanced atherosclerosis has been reported (9). Recent studies have shown not only an increased local ET-1 concentration (10) but also increased ET-1 mRNA in arteries containing atherosclerotic lesions (11).

Risk factors for the development of atherosclerosis, such as diabetes, also seem to be associated with elevated plasma ET-1 levels (12). Late complications in patients with diabetes such as nephropathy, neuropathy, and retinopathy are associated with at least 2 pathophysiological conditions: 1) enhanced development and accumulation of advanced glycation end products (AGEs) and 2) an increased formation of intracellular oxidative stress (13,14).

Proteins exposed to glucose become nonenzymatically glycosylated, resulting in the formation of Amadori products. The best known Amadori product is HbA_{1c}, which is used for monitoring glucose metabolism in patients with diabetes. Longer-lasting exposure leads to formation of irreversibly glycosylated proteins. These AGEs are formed and accumulate in the vessel wall during normal aging. Their formation and accumulation increase in patients with long-lasting hyperglycemia as occurs in diabetes (15). Accumulation of AGEs in the vessel wall and different organs seems to be linked to the development of microvascular and macrovascular disease and other secondary complications of diabetes. Administration of AGE albumin to healthy nondiabetic animals was followed by vascular dysfunction similar to that associated with experimental diabetes (16). This cellular response is thought to be mediated through the binding of AGEs to a specific cell-surface receptor (the receptor for advanced glycation end products [RAGE]) (17). Inhibition of

From the Departments of Medical and Chemical Laboratory Diagnostics (P.Q., C.M., W.S.) and Internal Medicine III (P.F.), University of Vienna, Vienna, Austria; the European Molecular Biology Laboratory-Heidelberg (G.S., M.S.), Heidelberg; and the Vascular Medicine Section (A.B., M.K., M.H., E.S., P.P.N.), Department of Internal Medicine IV, University of Tübingen, Tübingen, Germany.

Address correspondence and reprint requests to Peter P. Nawroth, MD, Vascular Medicine Section, Department of Internal Medicine IV, University of Tübingen, Otfried Müller Str. 10, 72076 Tübingen, Germany.

Received for publication 30 December 1998 and accepted in revised form 17 May 2000.

AGE, advanced glycation end product; AMV, avian myeloblastosis virus; BAEC, bovine aortic endothelial cell; BSA, bovine serum albumin; CML, N^ε-(carboxymethyl)lysine; DTT, dithiothreitol; EC, endothelial cell; ECL, enhanced chemiluminescence; EMSA, electrophoretic mobility shift assay; ET-1, endothelin 1; FCS, fetal calf serum; GAPDH, glyceraldehyde-3-phosphate dehydrogenase; HPLC, high-performance liquid chromatography; Ig(c), constant Ig domain; IgSF, immunoglobulin superfamily; Ig(v), variable Ig domain; I- κ B α , cytoplasmic inhibitor of NF- κ B; NF- κ B, nuclear factor- κ B; pDTC, pyrrolidine-dithiocarbamate; PIP, phosphatidylinositol 4-phosphate; PMSF, phenylmethylsulfonyl fluoride; RAGE, receptor for advanced glycation end products; RT-PCR, reverse transcriptase-polymerase chain reaction; sRAGE, soluble RAGE; SSC, sodium chloride-sodium citrate; SV, simian virus; TBS, Tris-buffered saline; TBST, Tris-buffered saline with Tween.

AGE-RAGE interaction affects hyperpermeability (18) and macrovascular arteriosclerosis (19). Ligand receptor interaction results in the generation of intracellular oxidative stress and activation of the redox-sensitive transcription factor nuclear factor- κ B (NF- κ B) (20,21). Patients with poor glycemic control and diabetic nephropathy have been shown to have elevated levels of AGEs (22,23), oxidative stress (24), mononuclear NF- κ B binding activity (25), and elevated levels of ET-1 (9,11,12). Therefore, we asked whether AGE-RAGE-dependent NF- κ B activation could contribute to ET-1 induction.

RESEARCH DESIGN AND METHODS

Reagents. Reagents were obtained as follows: DMEM, RPMI-1640, HEPES buffer solution, L-glutamine, penicillin/streptomycin mixture, and phosphate-buffered saline (pH 7.4) were from Biowhittaker (Walkerville). Fetal calf serum (FCS) was from Boehringer Mannheim (Mannheim, Germany). [α - 32 P]dCTP (3,000 Ci/mmol at 10 Ci/ml), [α - 32 P]UTP (3,000 Ci/mmol at 10 Ci/ml), [γ - 32 P]ATP (3,000 Ci/mmol at 10 Ci/ml), and Hybond-N nylon filter were obtained from Amersham (Braunschweig, Germany). Ficoll-Paque was from Pharmacia (Uppsala, Sweden). Benzamidine, leupeptin, phenylmethyl-sulfonyl fluoride (PMSF), pyrrolidine-dithiocarbamate (pDTC), and soybean inhibitor were obtained from Sigma (St. Louis, MO).

Isolation and Western blot of N^c-(carboxymethyl)lysine-modified proteins. Erythrocytes were lysed in 0.9% NaCl, 1.5 mmol/l PMSF, 0.1 mmol/l leupeptin, 20 mg/ml soybean inhibitor, and 2 mmol/l benzamidine by 3 freeze/thaw cycles followed by pulsed ultrasonication for 3 min and a final freeze/thaw cycle. Insoluble material was removed by 5 min of centrifugation at 6,000 rpm at 4°C, and the supernatant was used for N^c-(carboxymethyl)lysine (CML) extraction.

Isolation of CML-modified proteins from erythrocyte lysates was performed as follows. CML-modified proteins, anti-CML-coupled sepharose, and an unrelated control antibody-coupled sepharose were prepared as previously described in detail (26). A total of 10 μ g total erythrocyte lysate from 1 patient (HbA_{1c} 14.3%) was loaded onto a 1-ml anti-CML-sepharose column or a 1-ml anti-phosphatidylinositol 4-phosphate (PIP) kinase-coupled sepharose column and was incubated for 2 h at room temperature while shaken continuously. After extensive washing with 7 \times 10 ml 0.9% NaCl, CML-modified proteins were eluted with 1 mol/l glycine (pH 3.0), were neutralized, and were dialyzed before protein concentration was determined using the bicinchoninic acid assay system (Pierce, Rockford, IL).

Furthermore, 50 μ g total erythrocyte lysate or 5 μ g material eluted from CML-sepharose columns or control antibody-sepharose columns was loaded onto 10% SDS-PAGE followed by electroblotting to enhanced chemiluminescence (ECL)-nitrocellulose membranes. Blocking was performed overnight at 4°C in 0.2% casein (I-Block; Tropic, Bedford, MA) dissolved in Tris-buffered saline (TBS) supplemented with 0.1% Tween (TBST). Membranes were incubated for 45 min at room temperature with a primary antibody for CML diluted 1:8,000 in blocking solution. Membranes were washed for 2 \times 15 min in TBST before the secondary antibody (horseradish peroxidase-coupled rabbit IgG, 1:3,000) was added, and incubation continued for 30 min at room temperature. Membranes were washed 3 \times 15 min as above followed by detection of immunoreactive proteins using the ECL Western blot system (Amersham, Braunschweig, Germany) from 10 s to 1 min.

Preparation of soluble RAGE. The first Ig domain (residues 21–132) of the human RAGE receptor was cloned into a modified pET9D expression vector (Novagen, Madison, WI) and was overexpressed in *Escherichia coli*. The sequence was confirmed by DNA sequencing. The 111-residue recombinant protein was purified by affinity chromatography on a Ni-chelating sepharose fast flow column (Pharmacia, Freiburg, Germany) followed by gel filtration. Based on 1- and 2-dimensional nuclear magnetic resonance experiments, the recombinant Ig domain adopts a tertiary structure and is folded. Competition with a 3-fold molar excess of the recombinant Ig domain results in reduced cellular activation mediated by ligand binding to RAGE.

Preparation of AGE albumin. AGE albumin was prepared by preincubation of bovine serum albumin (BSA) with 200 mmol/l glucose at 37°C for 4–8 weeks in 100 mmol/l phosphate (pH 7.4) and 0.5 mmol/l sodium azide. At the end of incubation, AGE albumin was dialyzed against 100 mmol/l phosphate for 24 h and 0.9% NaCl for 12 h. Nonglycated BSA, heat-inactivated AGE, and BSA incubated with the synthetic substrate sorbitol served as negative controls. AGE albumin preparations were characterized by chromatographic means (27). Fructoselysine, pyrrolidine, and unmodified lysine were quantified after enzymatic hydrolysis via ion-exchange chromatography with direct

ultraviolet detection and subsequent ninhydrin derivatization. Quantification of pentosidine was obtained in acid hydrolysates using ion-exchange chromatography with direct fluorescence detection. Carboxymethyl lysine and other amino acids were quantified on the amino acid analyzer after acid hydrolysis. Lysine modifications of the used AGE preparations varied from 10 to 36%. Assays for endotoxin showed that AGE albumin preparations contained virtually undetectable levels of lipopolysaccharide (<10 pg/ml at a protein concentration of 5 mg/ml).

Plasmids. The simian virus (SV) 40-driven luciferase control plasmid pGL2-control, the promoterless plasmid pGL2-basic, the β -galactosidase control plasmid pSV- β -Gal, and the chloramphenicol transferase control vector pCAT-control were obtained from Promega (Madison, WI). NF- κ B p50, NF- κ B p65, and the cytoplasmic inhibitor of NF- κ B (I- κ B α) were provided by Dr. P.A. Baeuerle (Tularik, San Francisco, CA). Human ET-1 cDNA was a gift from Dr. T. Yanagisawa (Kyoto, Japan). For functional promoter studies, the 3,604-bp long 5' flanking region of the human ET-1 gene was inserted into the multiple cloning site of the plasmid pGL2-basic after digestion with *Kpn*I and *Bgl*II (pET[-3,604]Luc). The plasmid pET[-490]Luc, which lacks the potential NF- κ B binding site, was generated through digestion of pET[-3,604]Luc with Exonuclease III (Promega). All plasmids were verified by sequencing using GLprimer 1 and GLprimer 2 from Promega.

Tissue culture. Bovine aortic endothelial cells (BAECs) were cultured in DMEM supplemented with 10% FCS as previously described (28), and primary cultures were established according to Jaffe et al. (29). Cells were identified as ECs by positive immunofluorescence staining for von Willebrand factor antigen and according to typical morphological features. BAECs were passaged every 8–10 days without showing morphological changes. All experiments were performed with BAECs at passages 4–6, which had been confluent for 3 days. For transfection experiments, BAECs growing in the logarithmic phase were used.

Measurement of HbA_{1c} and isolation of erythrocytes. HbA_{1c} levels of venous blood samples anticoagulated with EDTA (Becton Dickinson Vacutainer system; Meylan Cedex, France) from 55 patients with type 2 diabetes were assayed by a routinely used high-performance liquid chromatography (HPLC) method based on the procedure described by Bissegger and Wieland (30) on a Shimadzu HPLC system (Kyoto, Japan). The nondiabetic reference range for HbA_{1c} is 4–6%. A total of 21 patients had HbA_{1c} levels between 6.0 and 7.9%, and 29 patients had HbA_{1c} levels >8.0%. The patients did not receive therapy other than antidiabetic drugs. The control group consisted of 10 healthy nondiabetic volunteers. Written consent was obtained from all participants after explaining the nature of the procedure.

EDTA-anticoagulated blood was centrifuged to remove plasma and buffy coat, and packed erythrocytes were washed 2 times before incubating 4 \times 10⁹ BAECs with 4 \times 10⁹ erythrocytes for 24 h (18,21,31).

Determination of ET-1. ET-1 was purified from tissue culture supernatants by methanol extraction from Sep-Pak Plus C₁₈ cartridges (Millipore, Milford, MA). The eluted samples were then applied to a radioimmunoassay based on rabbit anti-ET-1 serum and a ¹²⁵I-ET-1 tracer (Biomedica, Vienna, Austria). Radioimmunoassay was performed according to the manufacturer's instructions. The assay showed an intra-assay coefficient of variation <3% and an interassay coefficient of variation of 12%.

RNA isolation and Northern blot hybridization. After induction, cells were pelleted, and total RNA was prepared as described by Chirgwin et al. (32). For Northern blot analysis, RNA samples of 20 μ g each were size fractionated by 1.2% formaldehyde agarose gel electrophoresis and were transferred to Hybond-N membranes (Amersham, Braunschweig, Germany). The filters were baked at 80°C for 2 h, were prehybridized for 2 h, and were then hybridized for 12–16 h at 65°C in 50 mmol/l PIPES buffer (pH 6.8), 200 mmol/l NaCl, 20 mmol/l Na₂HPO₄, 30 mmol/l NaH₂PO₄, 1 mmol/l EDTA, 5% SDS, and 100 μ g/ml sonicated salmon sperm DNA. A 480-bp *Sac*I insert of the ET-1 cDNA was labeled with [α - 32 P]dCTP by the random prime technique (33) and was used as an ET-1-specific probe. The blots were washed 3 times with prewarmed 1.3 \times sodium chloride-sodium citrate (SSC) and 5% SDS at 65°C. Filters were exposed for 2 days at -70°C to Kodak XAR-5 films (Rochester, NY) using intensifying screens.

Reverse transcriptase-polymerase chain reaction. For reverse transcriptase-polymerase chain reaction (RT-PCR), total RNA was prepared using the RNeasy Kit (Qiagen, Hilden, Germany) according to the manufacturer's instructions. RT-PCR for ET-1 followed the protocol of Ehrenreich (34) with minor modifications. cDNA was reverse transcribed from 1 μ g of total RNA with oligo-dT primers (Pharmacia, Freiburg, Germany) and avian myeloblastosis virus (AMV)-reverse transcriptase (Promega, Heidelberg, Germany). Amplification was performed using the primer pairs ET-1 forward primer 5'-GTCAACACTCCGAGCAGC-3', ET-1 reverse primer 5'-CTGGTTTGCTTA GGTGTTCC-3', actin forward primer 5'-AGAGGTATCCTGACCTGAAGTA

CC-3', and actin reverse primer 5'-CCACCAGACAACACTGTGTGGCAT-3' under the following conditions: 1 × [95°C, 360 s], 1 × [94°C, 45 s; 52°C, 120 s; 72°C, 60 s], 1 × [94°C, 45 s; 55°C, 120 s; 72°C, 60 s], 32 × [94°C, 45 s; 60°C, 45 s; 72°C, 45 s], 1 × [72°C, 600 s] for ET-1 and 1 × [95°C, 360 s], 1 × [94°C, 45 s; 52°C, 120 s; 72°C, 90 s], 1 × [94°C, 45 s; 58°C, 90 s; 72°C, 60 s], 33 × [94°C, 40 s; 65°C, 60 s; 72°C, 90 s], and 1 × [72°C, 600 s] for actin. Amplification products were separated onto 2% agarose gels. Reactions lacking template RNA or AMV-reverse transcriptase and reamplification with different primer pairs recognizing sequences internal to the amplification products served as internal controls.

Nuclear run-on assay. Nuclear run-on assays were performed according to the procedure of Greenberg and Ziff (35). Briefly, after incubation with AGEs, or 42 h after transfection, nuclei were harvested from 2×10^7 cells. Run-on reactions were performed in 0.7 mol/l KCl, 50 mmol/l MgCl₂, 50 mmol/l Tris-HCl (pH 8.0), 25 mmol/l dithiothreitol (DTT), and 1 mmol/l EDTA in the presence of 250 μCi [³²P]UTP (3,000 Ci/mmol) and were incubated for 30 min at 30°C. The synthesized mRNA was incubated with DNase I for 5 min at 30°C, was treated with proteinase K (10 mg/ml), and was extracted with 0.45 μm millipore filters HA. RNA was collected by ethanol precipitation and was redissolved in 300 μl diethyl pyrocarbonate-H₂O; 1 μl was counted, and equal numbers of Cerenkov counts were made up to 2 ml hybridization solution and were added to the previously prepared dot blot filters. Hybridization was performed without prehybridization in 50% formamide, 5 × SSC, 5 × Denhardt solution, and 1% SDS for 4 days at 42°C. Filters were washed 3 times at room temperature for 10 min in 2 × SSC and once at 60°C in 1 × SSC. Filters were exposed to Kodak XAR-5 films for 1–4 weeks at -70°C with intensifying screens. For preparation of filters, 3 μg human ET-1 DNA or the respective control plasmids (glyceraldehyde-3-phosphate dehydrogenase [GAPDH]) were applied to Hybond-N membranes using a dot blot apparatus (Schleicher & Schuell, Dassel, Germany).

Application of phosphorothioate oligonucleotides. The sequence of the used bovine RAGE antisense oligonucleotide is 5'-GACCACTGCCCTGCTGC-3', and the sequence of the human RAGE antisense oligonucleotide is 5'-AACTGCTGTCCGGCTGC-3'. They comprise the region from +13 bp to +30 bp of the bovine and from +4 bp to +21 bp of the human published DNA sequence for RAGE (36). The used RAGE sense oligonucleotide sequences are complementary to the described sequences. They were synthesized on a Gene Assembler Plus (Pharmacia, Freiburg, Germany) and were purified on histidine gels (37). To protect oligonucleotides against nuclease-mediated degradation, they were synthesized as phosphorothioate derivatives. Oligonucleotides were added to cell culture medium at a concentration of 0.1 μmol/l and were applied 48 h before incubation with 500 nmol/l AGEs. Stability, internalization, and successful downregulation of RAGE mRNA synthesis through antisense oligonucleotides were monitored by RT-PCR as described previously (38).

Transient transfection of BAECs. Logarithmically growing ECs were transfected as described by Lee et al. (39) with minor modifications (40). Plasmid DNA used in transfection was isolated by CsCl equilibrium centrifugation (41). Cells growing in DMEM containing 10% FCS were transfected by the calcium phosphate method and were exposed to the precipitate for 8 h. The medium was changed, and cells were incubated for 42 h and then harvested in the appropriate buffers. Cell extracts were prepared by lysis in 25 mmol/l Tris-phosphate (pH 7.8), 2 mmol/l DTT, 2 mmol/l 1,2-diaminocyclohexane-N,N,N,N-tetraacetic acid, 10% glycerol, and 1% Triton X-100 and were assayed directly for luciferase activity and β-galactosidase activity as previously described (40). The ratio of luciferase activity to β-galactosidase activity served to normalize the luciferase activity. Each experiment was performed in triplicate at least 3 times.

Electrophoretic mobility shift assay. For electrophoretic mobility shift assays (EMSA), nuclear proteins were harvested as previously described (40) and were assayed for NF-κB binding activity using the following oligonucleotides: the NF-κB consensus sequence 5'-AGTTGAGGGGACTTTCCCA GGC-3' and the ET-1-derived NF-κB sequence 5'-AAGTAGGGGAGTCCCTG CCAAGAC-3'. The oligonucleotides were end labeled with polynucleotide kinase in the presence of [³²P]ATP to a specific activity >5 × 10⁷ cpm/μg DNA. Specificity of binding was ascertained by competition with a 160-fold molar excess of unlabeled consensus oligonucleotides.

Data analysis. Data are means (ranges). Because of nonnormal distribution, nonparametric tests were used. For comparisons between the groups, the Kruskal-Wallis analysis of variance and the Mann-Whitney *U* test were applied. Spearman's rank correlation test was used to calculate correlations.

RESULTS

Erythrocytes isolated from patients with type 2 diabetes are able to induce ET-1 in cultured ECs. The 4×10^5 BAECs were incubated with 4×10^9 isolated erythrocytes from patients with type 2 diabetes ($n = 55$) and from 10

healthy control subjects to study whether hyperglycemia-dependent modification of erythrocyte membrane proteins affects ET-1 production of ECs. The ET-1 content of the supernatant was determined by a radioimmunoassay 24 h after the addition of erythrocytes. In this experimental setting, an increase in ET-1 was observed that correlated with the HbA_{1c} levels of the patients ($r = 0.77$) with a maximum increase at HbA_{1c} levels >8.0% ($P < 0.00001$, Fig. 1A). Thus, erythrocytes derived from diabetic patients with poor glycemic control had a stronger ET-1-inducing activity on BAECs than erythrocytes derived from patients with good glycemic control. Hyperglycemia is associated with increased formation of AGEs.

Consistently, Western blot analysis performed with antibodies directed against CML demonstrated that total erythrocyte lysates from hyperglycemic patients (HbA_{1c} 14.3%) contained more CML-reactive material than erythrocyte lysates derived from subjects with good glycemic control (Fig. 1B). Two prominent bands were detected. The upper band of an apparent molecular weight of 70 kD was found only in the erythrocytes of patients with bad glycemic control, and a lower band of ~30 kD was present in all extracts tested. When erythrocytes from hyperglycemic patients were enriched for CML-modified proteins using an anti-CML antibody coupled to BrCN-activated sepharose, CML-modified proteins were isolated (Fig. 1C). The 30-kD protein could not be recovered after elution and thus may represent a protein with only minor CML modifications.

Recently, researchers have shown that CML-modified proteins recognize RAGE (42). The primary sequence of human RAGE consists of 3 Ig domains followed by a hydrophobic transmembrane region and a 43-residue cytosolic domain at the COOH-terminal (36). The first Ig domain belongs to the subfamily of variable Ig domains, Ig(v), whereas the second and third are of the constant type, Ig(c). For many extracellular regions of the immunoglobulin superfamily (IgSF), the Ig domain that is located furthest from the membrane and thus closest to a potential ligand is Ig(v). Furthermore, Ig(v) domains are often found to be necessary and sufficient for ligand binding of the extracellular domain of IgSF cell-surface receptors (43,44). Therefore, we overexpressed the NH₂-terminal Ig(v) domain of human RAGE. The addition of this recombinant peptide derived from the IgG-like RAGE domain (soluble RAGE [sRAGE]) as a decoy reduced AGE-RAGE interaction and erythrocyte-derived CML-containing protein-dependent ET-1 induction (Fig. 1D). Therefore, ET-1 induction by CML-containing erythrocyte-derived protein isolated from patients with poor glycemic control is in part dependent on RAGE.

AGEs are able to induce ET-1 in vitro. Elevated ET-1 has been observed in diabetic patients and in complications associated with elevated levels of AGEs (12,45), oxidative stress (24), and increased NF-κB binding activity (25). AGEs prepared in vitro by incubating BSA with 200 mmol/l glucose at 37°C for 4–8 weeks resulted in 10–36% lysine modification. Incubation of BAECs with AGE albumin resulted in a RAGE-dependent ET-1 induction because antisense RAGE but not sense RAGE oligonucleotides blocked ET-1 induction in nuclear run-on assays (Fig. 2A). Thus, both sRAGE as a decoy and blocking RAGE expression (38) reduce AGE-mediated ET-1 induction. The AGE albumin-mediated ET-1 induction was time and dose dependent (Figs. 2B and C, 3A

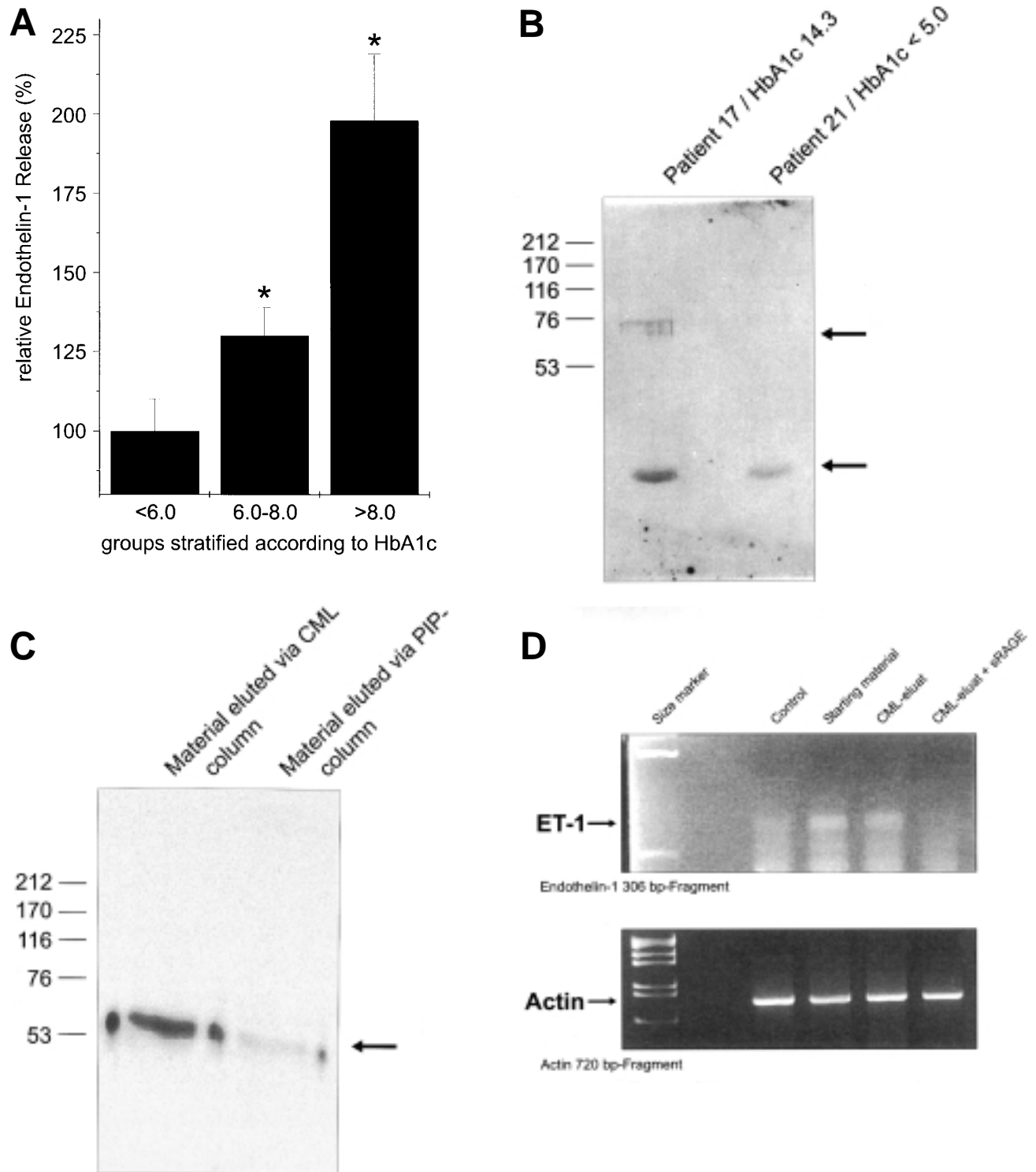

FIG. 1. ET-1 expression in BAECs is induced by erythrocytes of patients with type 2 diabetes. **A:** The 4×10^5 BAECs were incubated for 24 h with 4×10^9 erythrocytes derived from patients with type 2 diabetes. Induction was dependent on patients' HbA_{1c} levels and was most pronounced in the group of patients with HbA_{1c} levels >8.0% ($P < 0.00001$ vs. groups with HbA_{1c} levels <6% and between 6.0 and 8.0%, respectively). * $P < 0.00001$. **B:** Western blot analysis using an antibody directed against CML demonstrated that the erythrocyte lysate of a patient with poor glycemic control (left lane) contained more CML-reactive material than the erythrocyte lysate of a control subject (right lane). Two prominent bands were detected (arrows). The upper band of approximately 70 kD was restricted to erythrocytes derived from patients with bad glycemic control, whereas the lower band of ~30 kD was present in all extracts tested. **C:** Western blot analysis confirmed that material eluted from the CML-sepharose column was enriched for CML-modified proteins with a size of ~56 kD (left lane, arrow). Material eluted from the PIP kinase-coupled control column did not react with the CML-specific antibody (right lane). **D:** BAECs were incubated with 32.5 μ g total erythrocyte lysate (starting material) or with CML eluate for 5 days. Where indicated, BAECs were incubated with CML eluate in the presence of sRAGE spanning AA21–132 of the extracellular domain of RAGE. At the end of incubation, cells were harvested, and total RNA was prepared as described in RESEARCH DESIGN AND METHODS and was subjected to RT-PCR using ET-1-specific primer (top, arrow) and actin-specific primer (bottom, arrow), respectively.

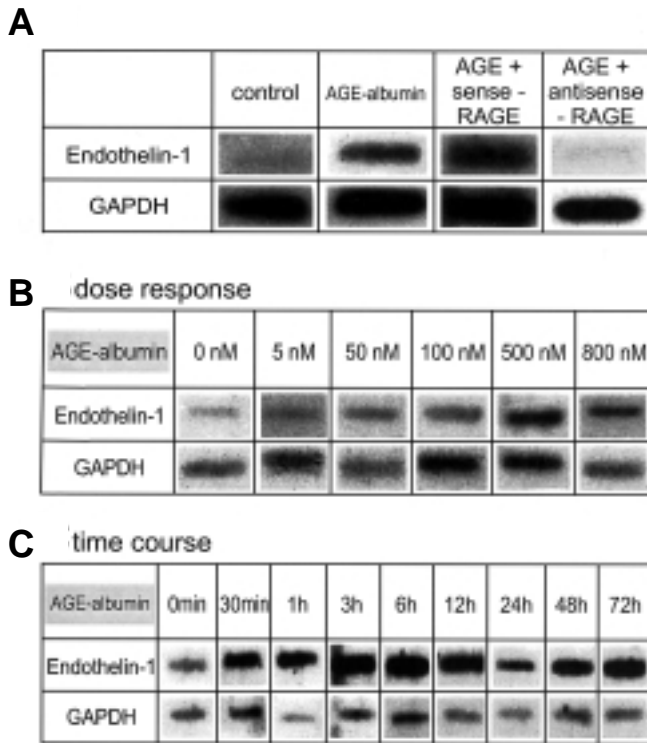

FIG. 2. ET-1 induction through AGE albumin in a nuclear run-on assay. Nuclei were extracted from BAECs that were incubated for 48 h with 0.1 $\mu\text{mol/l}$ sense or antisense phosphorothioate oligonucleotides to RAGE before the addition of 500 nmol/l AGE albumin for 12 h (A). BAECs were incubated with various concentrations of AGE albumin for 60 h (B) or with 500 nmol/l AGE albumin for various time periods (C). Nuclear run-on experiments were performed as described in RESEARCH DESIGN AND METHODS to allow in vitro synthesis of [α - ^{32}P]UTP-labeled mRNA. RNA was hybridized to Hybond-N membranes onto which cDNAs for ET-1 and GAPDH had been fixed.

and B). The dose-response curve has its half-maximum in the range of the dissociation constant of the AGE-RAGE interaction (17). The time course showed a rapid increase in ET-1 mRNA synthesis already present at 30 min. This fast induction of mRNA synthesis is comparable with other AGE-RAGE-controlled genes that are controlled by the redox-sensitive transcription factor NF- κ B. Neither normal albumin nor heat-inactivated AGE albumin had an effect on EC biological functions (data not shown).

Participation of the transcription factor NF- κ B in AGE-mediated ET-1 induction. BAECs were incubated with 10 $\mu\text{mol/l}$ pDTC. As shown in Fig. 4, pDTC reduces ET-1 induction, which suggests that AGE-mediated NF- κ B activation is involved in ET-1 induction (46). Consistently, transient transfection of BAECs with plasmids overexpressing I- κ B α leads to a partial inhibition of AGE-mediated ET-1 mRNA induction (Fig. 5). These data suggest that AGE-mediated ET-1 induction is controlled by NF- κ B. Therefore, transient transfection of BAECs with plasmids overexpressing NF- κ B p50 and p65 was performed. Induction of ET-1 mRNA through NF- κ B p50/p65 can be seen in Northern blot analysis. Overexpression of pCAT served as a control (Fig. 6). Thus, pDTC and overexpression of I- κ B α reduce AGE albumin-mediated ET-1 transcription, whereas overexpression of NF- κ B induces it, which is consistent with the hypothesis that AGE-

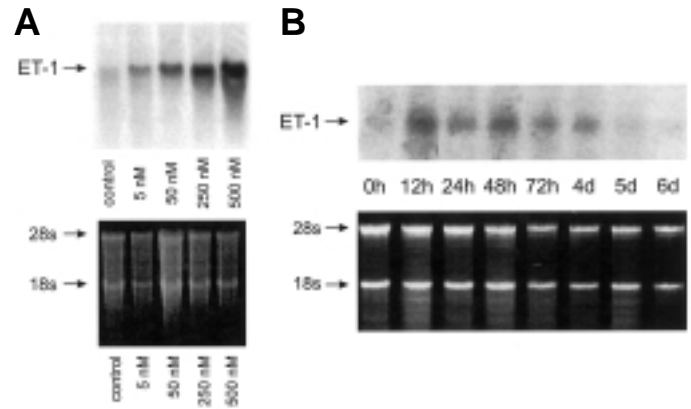

FIG. 3. AGE albumin induces ET-1 transcription in vitro. A: Dose dependence: BAECs were incubated with increasing concentrations of AGE albumin for 48 h. Total mRNA was isolated as described in RESEARCH DESIGN AND METHODS. Northern blot analysis was performed using a 480-bp *SacI* insert of the ET-1 cDNA (top). The bottom shows the 28- and 18-s RNA. B: Time dependence: BAECs were incubated with 500 nmol/l AGE albumin for different time periods. The ET-1 signals (top) and the 28- and 18-s RNA (bottom) are shown.

RAGE-dependent ET-1 induction is controlled by NF- κ B. Sequence analysis of the EMBL/GenBank database using the Heidelberg Unix Sequence Analysis Resources revealed a potential binding site for members of the NF- κ B family at position -2,090 bp (Fig. 7). The EMSA demonstrated AGE-inducible binding of protein complexes to this potential binding site. These protein complexes were characterized as NF- κ B-like proteins through blocking of binding with a 160-fold molar excess of cold consensus NF- κ B oligonucleotides (Fig. 8). The functional activity of this NF- κ B site was demonstrated using chimeric constructs containing the 5' flanking region of the ET-1 gene linked to luciferase as the reporter gene

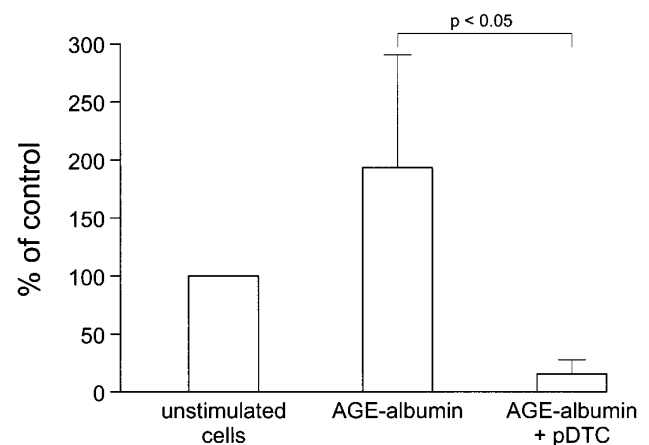

FIG. 4. Influence of the antioxidant pDTC on AGE-mediated ET-1 induction. BAECs were incubated with 500 nmol/l AGE albumin for 48 h alone or for 1 h with 10 $\mu\text{mol/l}$ pDTC before the addition of 500 nmol/l AGE albumin. The ET-1 content in cell culture supernatant was measured by radioimmunoassay. The ET-1 content in the supernatant of unstimulated cells served as a control and was taken as 100%. Data are means \pm SD of 3 independent experiments.

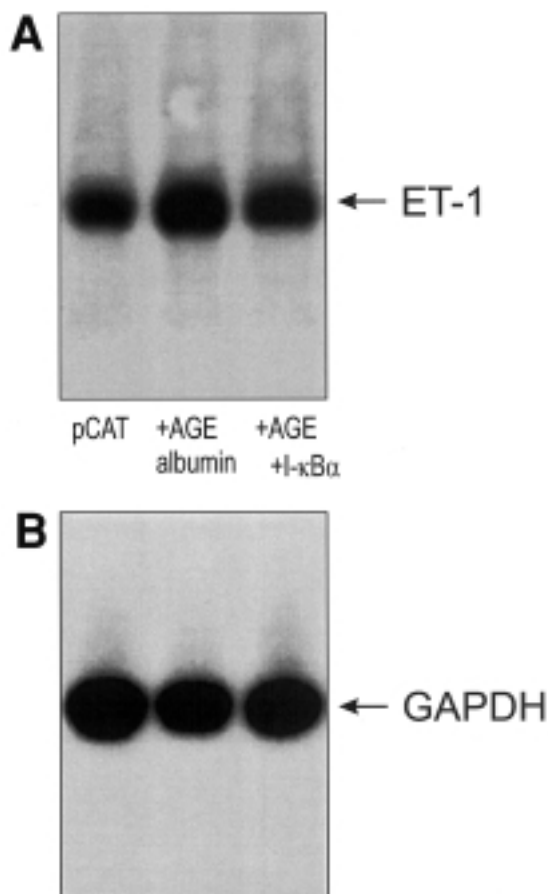

FIG. 5. I- κ B α inhibits AGE-mediated ET-1 induction. Total mRNA of BAECs transiently transfected with pCAT for 42 h in the absence (control, left lane) or presence of 500 nmol/l AGE albumin (center lane) or AGE-stimulated BAECs (42 h, 500 nmol/l, right lane) transiently transfected with plasmids overexpressing I- κ B α (0.8 μ g/ml medium) was hybridized with a 480-bp *Sac*I insert of the ET-1 cDNA (A). To show the same amount of RNA loading in each lane, filters were additionally hybridized with a probe for GAPDH (B).

expressed in BAECs by transient transfection. Stimulation of BAECs with 500 nmol/l AGE albumin for 42 h showed an increase in promoter activity after transient transfection of BAECs with pET[-3,604]Luc (Fig. 9). This induction through AGE albumin could not be detected in BAECs transiently transfected with pET[-490]Luc, which lacks the potential NF- κ B binding site at position -2,090 bp. In cotransfection experiments with plasmids overexpressing NF- κ B p50 and NF- κ B p65, an activation of the ET-1 promoter (pET[-3,604]Luc) was detected. This effect could be blocked through cotransfection with I- κ B α (Fig. 10). Transfection experiments with increasing concentrations of NF- κ B p50 showed a maximum of promoter activity at a concentration of 1.0 μ g p50 DNA, whereas higher concentrations reduced the promoter activity again (Fig. 11). This finding agrees with data from other groups showing that p50 homodimers have an inhibitory effect on NF- κ B-dependent gene transcription (47).

DISCUSSION

Formation, plasma levels, and tissue deposition of AGEs increase in patients with poor glycemic control and diabetic

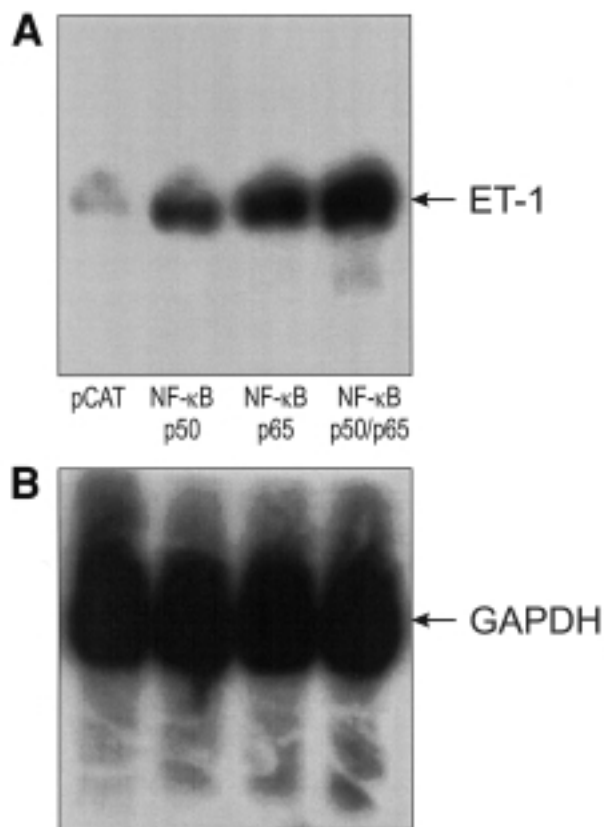

FIG. 6. NF- κ B p50/p65 is able to induce ET-1 mRNA. Total mRNA of BAECs transiently transfected with pCAT (control, far left lane) with plasmids overexpressing NF- κ B p50 (second lane from left), p65 (second lane from right), and p50 and p65 together (0.8 μ g each/ml medium, far right lane) was hybridized against ET-1-specific (A) or GAPDH-specific (B) probes.

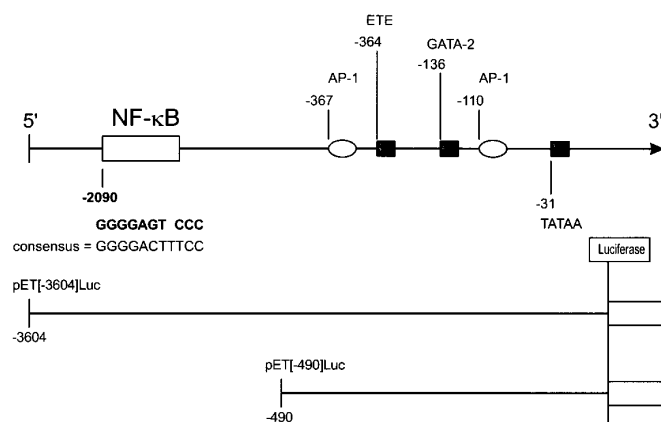

FIG. 7. Identification of an NF- κ B binding site in the human ET-1 gene. The organization of the human ET-1 promoter, which was cloned in front of the reporter gene luciferase, is shown in the upper part of the figure. Sequence analysis of the EMBL/GenBank database using the Heidelberg Unix Sequence Analysis Resources revealed a potential binding site for the transcription factor NF- κ B between -2,090 and -2,081 (numbers indicate the distance in base pairs upstream from the transcription start site, which is +1). In the lower part of the figure, a scheme of the ET-1 gene luciferase reporter constructs used in this study is shown. AP-1, activator protein 1 (57); ETE, EC transcriptional element (58); GATA-2, GATA binding protein 2 (59).

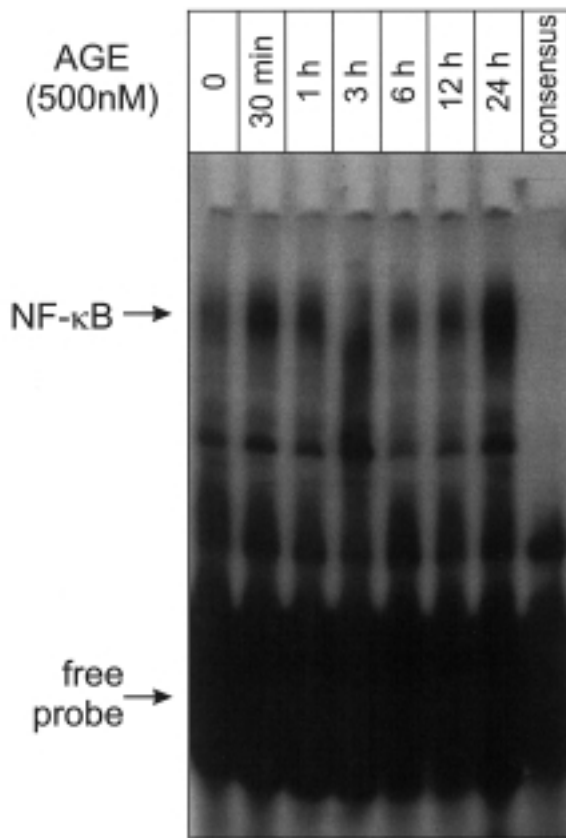

FIG. 8. AGE albumin induces binding of NF- κ B to the potential NF- κ B binding site of the human ET-1 promoter. Nuclear extracts were prepared from BAECs induced for various times (0–24 h) with AGE albumin (500 nmol/l). A total of 10 μ g nuclear extract was included in each binding reaction. DNA protein complexes were analyzed on 4% native polyacrylamide gels. EMSA detected NF- κ B binding to the potential NF- κ B binding site derived from the human ET-1 promoter. The AGE albumin-inducible NF- κ B complex is indicated with an arrow. Specificity of binding was ascertained by competing with a 160-fold molar excess of cold NF- κ B consensus oligonucleotides included in the binding reaction.

nephropathy (14,15,22,23). In these patients, increased oxidative stress, increased activation of NF- κ B, elevated levels of ET-1 antigen, and elevated ET-1 gene expression in the glomeruli have been described (23,25,45,48). Therefore, we investigated whether a link exists among hyperglycemia-dependent AGE formation, oxidative stress-dependent NF- κ B activation, and induction of ET-1 transcription. Clinical studies implicate an association of diabetic complications with increased ET-1 (45,49) and activation of NF- κ B (22,25). However, NF- κ B-dependent ET-1 regulation has not yet been described. Structural analysis of the ET-1 promoter revealed a putative NF- κ B binding site between –2,090 and –2,081 bp. This site is functionally active, as indicated by 1) inhibition of AGE-mediated ET-1 induction through the antioxidant pDTC (Fig. 4), 2) decreased ET-1 transcription after I- κ B α overexpression (Fig. 5), 3) increased ET-1 transcription after NF- κ B p50 and p65 overexpression (Fig. 6), and 4) promoter studies (Figs. 8–10). Thus, ET-1 belongs to the group of the AGE-, RAGE-, and NF- κ B-regulated genes such as tissue factor and vascular cell adhesion molecule (38,50–52). Consistent with these observations are previous

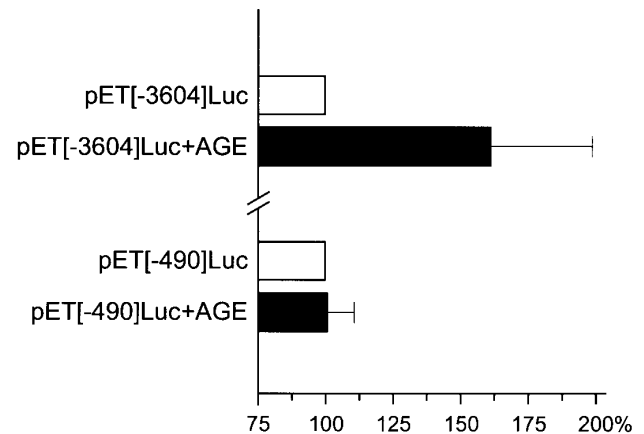

FIG. 9. AGE albumin-mediated ET-1 promoter activity and functional analysis of ET-1 expression in unstimulated (\square) and AGE albumin-induced (\blacksquare) BAECs. BAECs were transiently transfected with the promoter constructs pET[-3,604]Luc or pET[-490]Luc for 8 h before AGE albumin (500 nmol/l) was added for 42 h. After harvest, luciferase activity was determined in the cell lysates and was normalized for transfection efficiency to the amount of β -galactosidase activity expressed by the control plasmid pSV- β -Gal. Values are expressed as relative luciferase units and are given as percent of luciferase expression determined in unstimulated cells transfected with pET[-3604]Luc or pET[-490]Luc, whereas the basal luciferase expression for each construct was defined as 100%. Data are means \pm SD of at least 3 different experiments that were performed in triplicate.

reports describing NF- κ B-inducing agents as potent stimuli of ET-1 production (3–6,53).

The AGE-RAGE-mediated NF- κ B activation and subsequent NF- κ B-dependent ET-1 gene expression show a characteristic time course. Consistent with rapid protein synthesis, independent NF- κ B activation is the rapid AGE-RAGE-mediated induction of ET-1 transcription. The very long-lasting increase in the rate of ET-1 transcription is unusual and is much longer than that seen with stimuli-like cytokines, thrombin, or Ca²⁺ ionophores (3,5,54). Thus, AGE-RAGE-dependent ET-1 induction is characterized by its long-lasting time course. Inhibition of NF- κ B prevented ET-1 induction, even at later time points, and this is consistent with preliminary reports describing an AGE-RAGE-dependent sustained NF- κ B activation (55). This finding may explain the high abundance of ET-1 mRNA observed in atherosclerotic tissue. If ET-1 induction is only a short event, as suggested by in vitro experiments using cytokines, thrombin, or oxidized LDL (3–6,53), then only a few cells would be expected to be positive in vivo, whereas others are in a downregulated state. However, the high abundance of ET-1 mRNA in atherosclerotic tissue and the ET-1 positivity of almost all ECs in vivo (56) are more consistent with a perpetuated time course, as observed after AGE-RAGE interaction. The importance of AGE-RAGE interaction has been shown in 2 ways. First, an antisense oligonucleotide previously shown to downregulate RAGE and RAGE-dependent NF- κ B activation reduced ET-1 induction. Second, a peptide spanning the NH₂-terminal Ig(v) domain of human RAGE reduced AGE-dependent ET-1 induction. This region of RAGE has been shown to

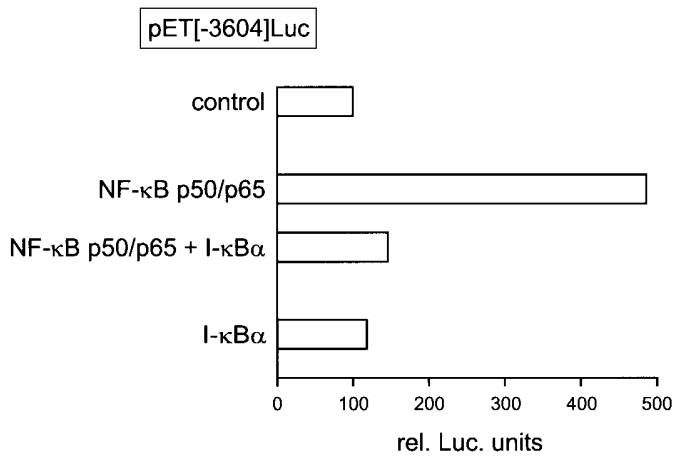

FIG. 10. Plasmids overexpressing NF- κ B p50/p65 induce ET-1 promoter activity. BAECs were cotransfected with the ET-1 promoter plasmids pET[-3,604]Luc and pCAT (control), NF- κ B p50 and p65, NF- κ B p50/p65 and I- κ B α , and I- κ B α alone (0.8 μ g each/ml medium) and were cultivated for 42 h. After harvest, luciferase activity was determined in the cell lysates and was normalized for transfection efficiency to the amount of β -galactosidase activity expressed by the control plasmid pSV- β -Gal. The normalized data are in relative Luc units (rel. Luc. units). Data are from 1 representative experiment of 3 performed in triplicate.

interact with CML proteins in functional assays (A.B., M.S., P.P.N., unpublished data). Because the CML-containing proteins were isolated from an erythrocyte lysate of diabetic patients, we assume that the proteins used are not exclusively CML modified but contain other AGE modifications as well. This indicates that not only CML-modified proteins use the RAGE region AA21–132 as their binding site.

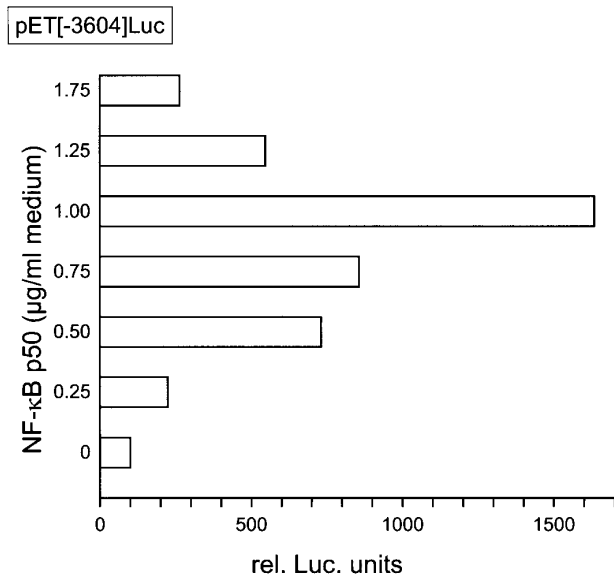

FIG. 11. NF- κ B p50 homodimers are able to reduce ET-1 promoter activity. BAECs were cotransfected with the ET-1 promoter plasmid pET[-3,604]Luc and increasing amounts of plasmids overexpressing NF- κ B p50 and were cultivated for 42 h. Luciferase activity was determined in the cell lysates and was normalized for transfection efficiency to the amount of β -galactosidase activity. The normalized data are in relative Luc units (rel. Luc. units). Data are from 1 representative experiment of 3 performed in triplicate.

The fact that in vitro-generated AGEs and hyperglycemia-dependent AGE-modified proteins isolated from an anti-CML column are able to induce ET-1 indicates that the AGE-mediated ET-1 induction is not an in vitro artifact. This conclusion is supported by a recent study showing that sRAGE protects hyperlipidemic diabetic mice from macrovascular atherosclerosis (19).

The data herein point to AGE-modified erythrocytes as potential sources of RAGE ligands, supporting a previous study that demonstrated binding of AGEs on the surface of erythrocytes to RAGE, which results in oxidative stress (21). This concept is expanded by our study showing that this interaction results at least in vitro in NF- κ B-dependent ET-1 induction.

ACKNOWLEDGMENTS

This work was supported in part by the Deutsche Forschungsgesellschaft (P.P.N., Na-138), a grant from the University of Heidelberg (A.B.), Stiftung VERUM (P.P.N.) and the Fortune-program of the University Tübingen (P.P.N., 679-0-0). P.P.N. performed this work during his tenure as a Schilling Professor, and P.Q. performed this work during his tenure as a scholar of the Hans and Blanca Moser Stiftung.

The authors thank Dr. T. Henle (Dresden, Germany) for characterization of AGE albumin and Dr. W. Schechinger (Tübingen, Germany) for providing the anti-PIP kinase antiserum. We thank Dr. P.A. Baeuerle for the NF- κ B p50, NF- κ B p65, and I- κ B α expression plasmids and Dr. T. Yanagisawa for the human ET-1 cDNA probe.

REFERENCES

1. Yanagisawa M, Kurihara H, Kimura S, Tomobe Y, Kobayashi M, Mitsui Y, Yazaki Y, Goto K, Masaki T: A novel potent vasoconstrictor peptide produced by vascular endothelial cells. *Nature* 332:411–415, 1988
2. Komuro I, Kurihara H, Sugiyama T, Takaku F, Yazaki Y: Endothelin stimulates *c-fos* and *c-myc* expression and proliferation of vascular smooth muscle cells. *FEBS Lett* 238:249–252, 1988
3. Yoshizumi M, Kurihara H, Morita T, Yamashita T, Oh-hashii Y, Sugiyama T, Takaku F, Yanagisawa M, Masaki T, Yazaki Y: Interleukin 1 increases the production of endothelin-1 by cultured endothelial cells. *Biochem Biophys Res Commun* 166:324–329, 1990
4. Marsden PA, Brenner BM: Transcriptional regulation of the endothelin-1 gene by TNF- α . *Am J Physiol* 262:C854–C861, 1992
5. Schini VB, Hendrickson H, Heublein DM, Burnett JC Jr, Vanhoutte PM: Thrombin enhances the release of endothelin from cultured porcine aortic endothelial cells. *Eur J Pharmacol* 165:333–334, 1989
6. Chua BHL, Chua CC, Diglio CA, Siu BB: Regulation of endothelin-1 mRNA by angiotensin II in rat heart endothelial cells. *Biochim Biophys Acta* 1178: 201–206, 1993
7. Dekker GA, Kraayenbrink AA, Zeeman GG, van Kamp GJ: Increased plasma levels of the novel vasoconstrictor peptide endothelin in severe pre-eclampsia. *Eur J Obstet Gynecol Reprod Biol* 40:215–220, 1991
8. Kimura S, Kasuya Y, Sawamura T, Shinimi O, Sugita Y, Yanagisawa M, Goto K, Masaki T: Conversion of big endothelin-1 to 21-residue endothelin-1 is essential for expression of full vasoconstrictor activity: structure-activity relationships of big endothelin-1. *J Cardiovasc Pharmacol* 13 (Suppl. 5):S5–S7, 1989
9. Lerman A, Edwards BS, Hallett JW, Heublein DM, Sandberg SM, Burnett JC Jr: Circulating and tissue endothelin immunoreactivity in advanced atherosclerosis. *N Engl J Med* 325:997–1001, 1991
10. Zeiher AM, Goebel H, Schachinger V, Ihling C: Tissue endothelin-1 immunoreactivity in the active coronary atherosclerotic plaque: a clue to the mechanism of increased vasoreactivity of the culprit lesion in unstable angina. *Circulation* 91:941–947, 1995
11. Winkles JA, Alberts GF, Brogi E, Libby P: Endothelin-1 and endothelin receptor mRNA expression in normal and atherosclerotic human arteries. *Biochem Biophys Res Commun* 191:1081–1088, 1993
12. Takahashi K, Ghatei MA, Lam HC, O'Halloran DJ, Bloom SR: Elevated plasma endothelin in patients with diabetes mellitus. *Diabetologia*

- 33:306-310, 1990
13. Wu JT: Review of diabetes: identification of markers for early detection, glycemic control, and monitoring clinical complications. *J Clin Lab Anal* 7:293-300, 1993
 14. Vlassara H, Bucala R, Striker L: Pathogenic effects of advanced glycosylation: biochemical, biologic, and clinical implications for diabetes and aging. *Lab Invest* 70:138-151, 1994
 15. Brownlee M, Cerami A, Vlassara H: Advanced glycosylation end products in tissue and the biochemical basis of diabetic complications. *N Engl J Med* 318:1315-1320, 1988
 16. Vlassara H, Fuh H, Makita Z, Krunkrai S, Cerami A, Bucala R: Exogenous advanced glycosylation endproducts induce complex vascular dysfunction in normal animals: a model for diabetic and aging complications. *Proc Natl Acad Sci U S A* 89:12043-12047, 1992
 17. Schmidt AM, Vianna M, Gerlach M, Brett J, Ryan J, Kao J, Esposito C, Hegarty H, Hurley W, Clauss M, Wang F, Pan YC, Tsang T, Stern D: Isolation and characterization of two binding proteins for advanced glycation end products from lung tissue which are present on the endothelial surface. *J Biol Chem* 267:14987-14997, 1992
 18. Wautier JL, Zoukourian C, Chappay O, Wautier MP, Guillausseau PJ, Cao R, Hori O, Stern D, Schmidt AM: Receptor-mediated endothelial cell dysfunction in diabetic vasculopathy. *J Clin Invest* 97:238-243, 1996
 19. Park L, Raman KG, Lee KJ, Lu Y, Ferran LJ, Chow WS, Stern D, Schmidt AM: Suppression of accelerated diabetic atherosclerosis by the soluble receptor for advanced glycation endproducts. *Nat Med* 4:1025-1031, 1998
 20. Yan SD, Schmidt AM, Anderson GM, Zhang J, Brett J, Zou YS, Pinsky D, Stern D: Enhanced cellular oxidative stress by the interaction of advanced glycation end products with their receptor/binding proteins. *J Biol Chem* 269:9889-9897, 1994
 21. Wautier JL, Wautier MP, Schmidt AM, Anderson GM, Hori O, Zoukourian C, Capron L, Chappay O, Yan SD, Brett J, Guillausseau PJ, Stern D: Advanced glycation end products (AGEs) on the surface of diabetic erythrocytes bind to the vessel wall via a specific receptor inducing oxidant stress in the vasculature: a link between surface-associated AGEs and diabetic complications. *Proc Natl Acad Sci U S A* 91:7742-7746, 1994
 22. Hofmann MA, Schiekofler S, Klevesath MS, Isermann B, Kanitz M, Henkels M, Joswig M, Treusch A, Morcos M, Weiss T, Borcea V, Abdel Khalek RKM, Amiral J, Tritschler H, Ritz E, Wahl P, Ziegler R, Bierhaus A, Nawroth PP: Peripheral blood mononuclear cells isolated from patients with diabetic nephropathy demonstrate increased activation of the oxidative-stress sensitive transcription factor NF- κ B. *Diabetologia* 42:222-232, 1999
 23. Makita Z, Radoff S, Rayfield EJ, Yang Z, Skolnik E, Delaney V, Friedman EA, Cerami A, Vlassara H: Advanced glycosylation end products in patients with diabetic nephropathy. *N Engl J Med* 325:836-842, 1991
 24. Borcea V, Nourooz-Zadeh J, Wolff SP, Klevesath M, Hofmann M, Ulrich H, Wahl P, Ziegler R, Tritschler H, Halliwell B, Nawroth PP: α -Lipoic acid decreases oxidative stress even in diabetic patients with poor glycemic control and albuminuria. *Free Radic Biol Med* 26:1495-1500, 1999
 25. Hofmann MA, Schiekofler S, Kanitz M, Klevesath MS, Joswig M, Lee V, Morcos M, Tritschler H, Ziegler R, Wahl P, Bierhaus A, Nawroth PP: Insufficient glycemic control increases nuclear factor- κ B binding activity in peripheral blood mononuclear cells isolated from patients with type 1 diabetes. *Diabetes Care* 21:1310-1316, 1998
 26. Schleicher ED, Wagner E, Nerlich AG: Increased accumulation of the glycooxidation product N^ε-(carboxymethyl)lysine in human tissues in diabetes and aging. *J Clin Invest* 99:457-468, 1997
 27. Henle T, Walter AW, Klostermeyer H: Simultaneous determination of protein-bound Maillard products by ion-exchange chromatography and photodiode array detection. In *Proceedings of the International Symposium on Maillard Reaction*. Labuza TP, Reineccius GA, Monnier VM, O'Brien J, Baynes JW, Eds. Minneapolis, MN, Royal Society of Chemistry, 1994, p. 195-200
 28. Schwartz SM: Selection and characterization of bovine aortic endothelial cells. *In Vitro* 14:966-970, 1978
 29. Jaffe EA, Nachmann RL, Becker CG, Minick CR: Culture of human endothelial cells derived from umbilical veins: identification by morphologic and immunologic criteria. *J Clin Invest* 52:2745-2756, 1973
 30. Bisse W, Wieland H: High performance liquid chromatographic separation of human hemoglobins, simultaneous quantitation of fetal and glycated hemoglobins. *J Chromatogr* 434:95-110, 1988
 31. Bierhaus A, Chevion S, Chevion M, Hofmann M, Quehenberger P, Illmer T, Luther T, Berentshtein E, Tritschler H, Müller M, Wahl P, Ziegler R, Nawroth P: Advanced glycation end product-induced activation of NF- κ B is suppressed by α -lipoic acid in cultured endothelial cells. *Diabetes* 46:1481-1490, 1997
 32. Chirgwin JM, Przybyla AE, MacDonald RJ, Rutter WJ: Isolation of biologically active ribonucleic acid from sources enriched in ribonuclease. *Biochemistry* 18:5294-5299, 1979
 33. Feinberg AP, Vogelstein B: A technique for radiolabeling DNA restriction endonuclease fragments to high specific activity. *Anal Biochem* 132:6-13, 1983
 34. Ehrenreich H, Rieckmann P, Sinowatz F, Weih KA, Arthur LO, Goebel FD, Burd PR, Coligan JE, Clouse KA: Potent stimulation of monocytic endothelin-1 production by HIV-1 glycoprotein 120. *J Immunol* 150:4601-4609, 1993
 35. Greenberg NE, Ziff ME: Stimulation of 3T3 cells induces transcription of *c-fos* protooncogene. *Nature* 311:433-448, 1984
 36. Neepner M, Schmidt AM, Brett J, Yan SD, Wang F, Pan YCE, Elliston K, Stern D, Shaw A: Cloning and expression of RAGE: a cell surface receptor for advanced glycosylation end products of proteins. *J Biol Chem* 267:14998-15004, 1992
 37. Mandecki W, Hayden M: High resolution polyacrylamide gel electrophoresis of oligonucleotides using L-histidine buffer. *DNA* 7:57-62, 1988
 38. Bierhaus A, Illmer T, Kasper M, Luther T, Quehenberger P, Tritschler H, Wahl P, Ziegler R, Müller M, Nawroth PP: Advanced glycation end product (AGE)-mediated induction of tissue factor in endothelial cells is dependent on RAGE. *Circulation* 96:2262-2271, 1997
 39. Lee ME, Bloch KD, Clifford JA, Quertermous T: Functional analysis of the endothelin-1 gene promoter: evidence for a cell-specific *cis*-acting sequence. *J Biol Chem* 265:10446-10450, 1990
 40. Bierhaus A, Zhang Y, Deng Y, Mackman N, Quehenberger P, Haase M, Müller T, Böhrer H, Greten J, Martin E, Baeuerle PA, Waldherr R, Kiesel W, Ziegler R, Stern DM, Nawroth PP: Mechanism of the tumor necrosis factor α -mediated induction of endothelial tissue factor. *J Biol Chem* 270:26419-26432, 1995
 41. Maniatis T, Fritsch EF, Sambrook J: *Molecular Cloning: A Laboratory Manual*. Cold Spring Harbor, NY, Cold Spring Harbor Laboratory Press, 1989
 42. Kislinger T, Fu C, Huber B, Qu W, Taguchi A, Yan SD, Hofmann M, Yan AF, Pischetsrieder M, Stern D, Schmidt AM: N^ε-(carboxymethyl)lysine adducts of proteins are ligands for receptor for advanced glycation end products that activate cell signaling pathways and modulate gene expression. *J Biol Chem* 274:31740-31749, 1999
 43. Bork P, Holm L, Sander C: The immunoglobulin fold: structural classification, sequence patterns and common core. *J Mol Biol* 242:309-320, 1994
 44. Skonier JE, Bowen MA, Emswiler J, Aruffo A, Bajorath J: Recognition of diverse proteins by members of the immunoglobulin superfamily: delineation of the receptor binding site in the human CD6 ligand ALCAM. *Biochemistry* 35:12287-12291, 1996
 45. Koide H, Nakamura T, Ebihara I, Fukui M: Endothelins in diabetic kidneys. *Kidney Int* 48 (Suppl. 51):45-49, 1995
 46. Schreck R, Meier B, Männel DN, Dröge W, Baeuerle PA: Dithiocarbamates as potent inhibitors of nuclear factor κ B activation in intact cells. *J Exp Med* 175:1181-1194, 1992
 47. Grimm S, Baeuerle PA: The inducible transcription factor NF- κ B: structure-function relationship of its protein subunits. *Biochem J* 290:297-308, 1993
 48. Kohan DE: Endothelins in the normal and diseased kidney. *Am J Kidney Dis* 29:2-26, 1997
 49. Bruzzi I, Remuzzi G, Benigni A: Endothelin: a mediator of renal disease progression. *J Nephrol* 10:179-183, 1997
 50. Ichikawa K, Yoshinari M, Iwase M, Wakisaka M, Doi Y, Iino K, Yamamoto M, Fujishima M: Advanced glycosylation end products induced tissue factor expression in human monocyte-like U937 cells and increased tissue factor expression in monocytes from diabetic patients. *Atherosclerosis* 136:281-287, 1998
 51. Schmidt AM, Hori O, Chen JX, Li JF, Crandall J, Zhang J, Cao R, Yan SD, Brett J, Stern D: Advanced glycation endproducts interacting with their endothelial receptor induce expression of vascular cell adhesion molecule-1 (VCAM-1) in cultured human endothelial cells and in mice. *J Clin Invest* 96:1395-1403, 1995
 52. May MJ, Ghosh S: Rel/NF- κ B and I κ B proteins: an overview. *Semin Cancer Biol* 8:63-73, 1997
 53. Boulanger CM, Tanner FC, Bea ML, Hahn AWA, Werner A, Lüscher TF: Oxidized low density lipoproteins induce mRNA expression and release of endothelin from human and porcine endothelium. *Circ Res* 70:1191-1197, 1992
 54. Vogel V, Kramer HJ, Backer A, Meyer-Lehnert H, Jelkmann W, Fandrey J: Effects of erythropoietin on endothelin-1 synthesis and the cellular calcium messenger system in vascular endothelial cells. *Am J Hypertens* 10:289-296, 1997
 55. Bierhaus A, Kanitz M, Tritschler H, Ziegler R, Nawroth PP: A new pathway of perpetuated NF- κ B activation potentially relevant in diabetes mellitus. *Exp Clin Endocrinol Diabetes* 106 (Suppl. 1):S20, V079, 1998

56. Bacon CR, Cary NRB, Davenport AP: Endothelin peptide and receptors in human atherosclerotic coronary artery and aorta. *Circ Res* 79:794-801, 1996
57. Lee ME, Dhadly MS, Temizer DH, Clifford JA, Yoshizumi M, Quertermous T: Regulation of endothelin-1 gene expression by Fos and Jun. *J Biol Chem* 266:19034-19039, 1991
58. Bu X, Quertermous T: Identification of an endothelial cell-specific regulatory region in the murine endothelin-1 gene. *J Biol Chem* 272:32613-32622, 1997
59. Wilson DB, Dorfman DM, Orkin SH: A nonerythroid GATA-binding protein is required for function of the human preproendothelin-1 promoter in endothelial cells. *Mol Cell Biol* 10:4854-4862, 1990